

## HS6E Subminiature Interlock Switches with Solenoid

### HS6E features:

- Compact body: 75 × 15 × 75 mm  
15-mm-wide, thinnest solenoid type interlock switch in the world.
- Reversible mounting and angled cable allow four actuator insertion directions.
- Energy saving. 24V DC, 110 mA (solenoid: 100 mA, LED: 10 mA)
- Manual unlocking possible on three sides.
- RoHS compliant
- LED indicator shows solenoid operation

### Spring Lock Type

- Automatically locks the actuator without power applied to the solenoid
- After the machine stops, unlocking is completed by the solenoid
- Manual unlocking is possible on three sides in the event of power failure or maintenance

### Solenoid Lock Type

- The actuator is locked when energized.
- The actuator is unlocked when de-energized.
- Flexible locking function can be achieved, for an application where locking is not required and sudden stopping of a machine must be prevented

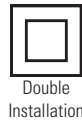

Overview

X Series E-Stops

Door Interlock Switches

### Part Numbers

Lock Mechanism	Circuit Number	Contact Configuration	Cable Length	Part Number (Standard Stock in bold)
Spring Lock	L	(Actuator inserted) (Solenoid OFF)	1m <b>3m</b> 5m	HS6E-L44B01-G
		Main Circuit: 1NC + 1NC, Monitor Circuit: 2NC/1NO Main Circuit:  11 12 41 42 Monitor Circuit:  21 22 53 54 Monitor Circuit:  31 32		<b>HS6E-L44B03-G</b> HS6E-L44B05-G
	M	Main Circuit: 1NC + 1NC, Monitor Circuit: 2NC/1NC Main Circuit:  11 12 41 42 Monitor Circuit:  21 22 53 52 Monitor Circuit:  31 32	1m <b>3m</b> 5m	HS6E-M44B01-G <b>HS6E-M44B03-G</b> HS6E-M44B05-G
		N	Main Circuit: 1NC + 1NC, Monitor Circuit: 1NC, 1NO/1NO Main Circuit:  11 12 41 42 Monitor Circuit:  21 22 53 54 Monitor Circuit:  33 34	1m <b>3m</b> 5m
P	Main Circuit: 1NC + 1NC, Monitor Circuit: 1NC, 1NO/1NC Main Circuit:  11 12 41 42 Monitor Circuit:  21 22 51 52 Monitor Circuit:  33 34	1m <b>3m</b> 5m	HS6E-P44B01-G <b>HS6E-P44B03-G</b> HS6E-P44B05-G	

### Part Number Key

HS6E - L 4 4 B 01 - G

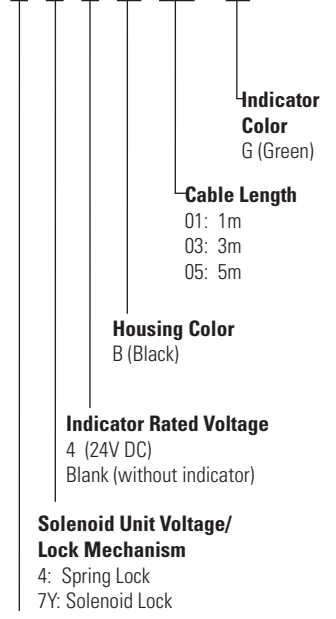

The contact configurations show the contact status when the actuator is inserted and locked. LED color is G (green) only. Actuator keys are not supplied with the interlock switch and must be ordered separately.

Enabling Switches

Barriers

AS-Interface Safety at Work

Lock Mechanism	Circuit Number	Contact Configuration	Cable Length	Part Number (Standard Stock in bold)
(Actuator inserted) (Solenoid ON) 				
Solenoid Lock	L	Main Circuit: 1NC + 1NC, Monitor Circuit: 2NC/1NO  Main Circuit: Monitor Circuit: Monitor Circuit:	1m <b>3m</b> 5m	HS6E-L7Y4B01-G <b>HS6E-L7Y4B03-G</b> HS6E-L7Y4B05-G
	M	Main Circuit: 1NC + 1NC, Monitor Circuit: 2NC/1NC  Main Circuit: Monitor Circuit: Monitor Circuit:	1m <b>3m</b> 5m	HS6E-M7Y4B01-G <b>HS6E-M7Y4B03-G</b> HS6E-M7Y4B05-G
	N	Main Circuit: 1NC + 1NC, Monitor Circuit: 1NC, 1NO/1NO  Main Circuit: Monitor Circuit: Monitor Circuit:	1m <b>3m</b> 5m	HS6E-N7Y4B01-G <b>HS6E-N7Y4B03-G</b> HS6E-N7Y4B05-G
	P	Main Circuit: 1NC + 1NC, Monitor Circuit: 1NC, 1NO/1NC  Main Circuit: Monitor Circuit: Monitor Circuit:	1m <b>3m</b> 5m	HS6E-P7Y4B01-G <b>HS6E-P7Y4B03-G</b> HS6E-P7Y4B05-G

The contact configurations show the contact status when the actuator is inserted and locked.  
 LED color is G (green) only.  
 Actuator keys are not supplied with the interlock switch and must be ordered separately.

**Actuator Keys**

Appearance	Item	Ordering Part Number	Remarks
	Straight Actuator	HS9Z-A61	The retention force of HS9Z-A61 actuator is 500N maximum. Do not apply excessive load.
	Right-angle Actuator	HS9Z-A62	The retention force of HS9Z-A62 actuator is 100N maximum. Do not apply excessive load. When retention force of 100N or more is required, use the HS9Z-A62S actuator.
	Right-angle Actuator with Mounting Plate	HS9Z-A62S	The retention force of HS9Z-A62S actuator is 500N maximum. Do not apply excessive load.
	Horizontal/Vertical Angle Adjustable Actuator	HS9Z-A65	The HS9Z-A65 and HS9Z-A66 have their metal actuator installed in opposite directions. Select actuator by determining the required moving direction in consideration of the door and interlock switch.
	Horizontal/Vertical Angle Adjustable Actuator	HS9Z-A66	See pages 370 and 373 for more information. The retention force of HS9Z-A65 and HS9Z-A66 500N maximum.

**Accessory**

Description	Part Number
Manual Unlock Key (long type)	HS9Z-T3

### Specifications

<b>Conforming to Standards</b>	UL 508 (UL listed), CSA C22.2, No. 14 (c-UL listed), ISO 14119 IEC 60947-5-1, EN 60947-5-1 (TÜV approval), EN 1088 (TÜV approval), GS-ET-19 IEC 60204-1/EN 60204-1 (applicable standards for use)	
<b>Operating Temperature</b>	-25 to +50°C (no freezing)	
<b>Storage Temperature</b>	-40 to +80°C (no freezing)	
<b>Operating Humidity</b>	45 to 85% (no condensation)	
<b>Rated Insulation Voltage (Ui)</b>	300V (between LED and ground: 60V)	
<b>Impulse Withstand Voltage (Uimp)</b>	Main & lock monitor circuits: 1.5 kV Door monitor circuit: 2.5 kV Between solenoid/LED and ground: 0.5 kV	
<b>Insulation Resistance (500V DC megger)</b>	Between live and dead metal parts: 100 MΩ minimum Between terminals of different poles: 100 MΩ minimum.	
<b>Contact Resistance</b>	300 mΩ maximum (initial value, 1m cable) 500 mΩ maximum (initial value, 3m cable) 700 mΩ maximum (initial value, 5m cable)	
<b>Electric Shock Protection Class</b>	Class II (IEC 61140)	
<b>Pollution Degree</b>	3	
<b>Degree of Protection</b>	IP67 (IEC 60529)	
<b>Vibration Resistance</b>	<b>Operating Extremes</b>	10 to 55 Hz, amplitude 0.35mm
	<b>Damage Limits</b>	30 Hz, amplitude 1.5 mm
<b>Shock Resistance</b>	<b>Operating Extremes</b>	100 m/s <sup>2</sup> (10G)
	<b>Damage Limits</b>	1000 m/s <sup>2</sup> (100G)
<b>Actuator Operating Speed</b>	0.05 to 1.0 m/s	
<b>Direct Opening Travel</b>	8.0 mm minimum	
<b>Direct Opening Force</b>	60N minimum	
<b>Actuator Retention Force</b>	500N maximum (GS-ET-19)	
<b>Operating Frequency</b>	900 operations/hour	
<b>Mechanical Life</b>	1,000,000 operations minimum (GS-ET-19)	
<b>Electrical Life</b>	100,000 operations minimum (rated load) 1,000,000 operations minimum (24V AC/DC, 100 mA) (operating frequency 900 operations/hr)	
<b>Conditional Short-circuit Current</b>	50A (250V) (Use 250V/10A fast-blow fuse for short-circuit protection.)	
<b>Cable</b>	UL2464, No. 22 AWG (12-core: 0.3 mm <sup>2</sup> or equivalent/core)	
<b>Cable Diameter</b>	ø7.6 mm	
<b>Weight</b>	Approx. 200g	

**Solenoid/Indicator**

<b>Locking Mechanism</b>		Spring Lock Type or Solenoid Lock Type
<b>Rated Voltage</b>		24V DC
<b>Current</b>		110 mA (solenoid 100 mA, LED 10 mA)
<b>Solenoid</b>	<b>Coil Resistance</b>	240Ω (at 20°C)
	<b>Pickup Voltage</b>	Rated voltage × 85% maximum (at 20°C)
	<b>Dropout Voltage</b>	Rated voltage × 10% minimum (at 20°C)
	<b>Maximum Continuous Applicable Voltage</b>	Rated voltage × 110%
	<b>Maximum Continuous Applicable Time</b>	Continuous
	<b>Insulation Class</b>	Class F
<b>Indicator</b>	<b>Light Source</b>	LED
	<b>Illumination Color</b>	Green

**Contact Ratings**

<b>Rated Insulation Voltage (Ui)</b>		300V (door monitor contact) 150V (lock monitor contact) 30V (between LED or solenoid and ground)				
<b>Rated Thermal Current (Ith)</b>	Operating temperature (−25 to 35°C)	2.5A (up to 2 circuits) 1.0A (3 or more circuits)				
	Operating temperature (35 to 50°C)	1.0A (1 circuit) 0.5A (2 or more circuits)				
<b>Rated Operating Current (Ie)</b>	Operating Voltage (Ue)		30V	125V	250V	
	Main and Lock Monitor Circuits	AC	Resistive load (AC12) Inductive load (AC15)	– 1A	2A 1A	– –
		DC	Resistive load (DC12) Inductive load (DC13)	2A 1A	0.4A 0.22A	– –
	Door Monitor Circuit	AC	Resistive load (AC12) Inductive load (AC15)	– 2.5A	2.5A 1.5A	1.5A 0.75A
		DC	Resistive load (DC12) Inductive load (DC13)	2.5A 2.3A	1.1A 0.55A	0.55A 0.27A



Minimum applicable load (reference value): 3V AC/DC, 5 mA

UL, c-UL rating

Main/Lock monitor circuit: 125V AC, 1A Pilot duty

125V DC, 0.22A Pilot duty

Door monitor circuit: 240V AC, 0.75A Pilot duty

250V DC, 0.27A Pilot duty

TÜV rating

Main/Lock monitor circuit: AC-15 125V/1A, DC-13 125V/0.22A

Door monitor circuit: AC-15 240V/0.75A, DC-13 250V/0.27A

Dimensions

Interlock Switch

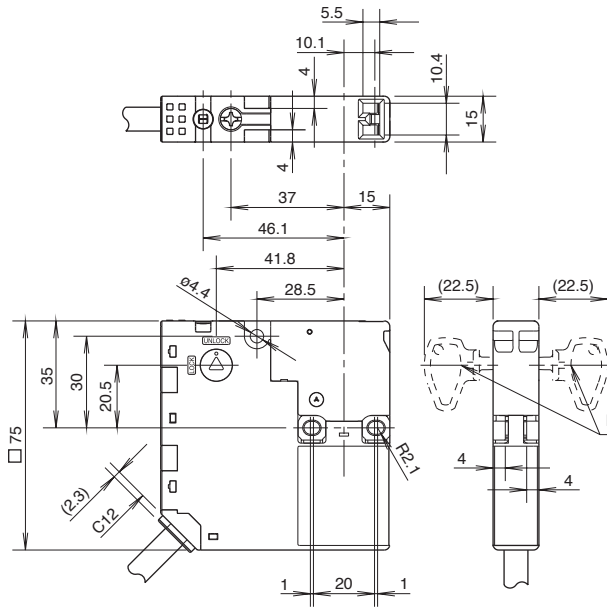

Mounting Hole Layout

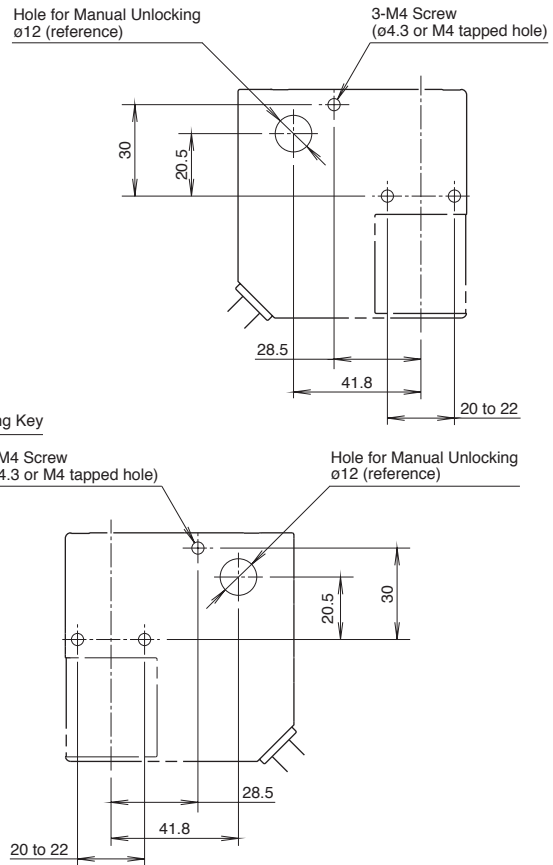

When using straight actuator (HS9Z-A61)

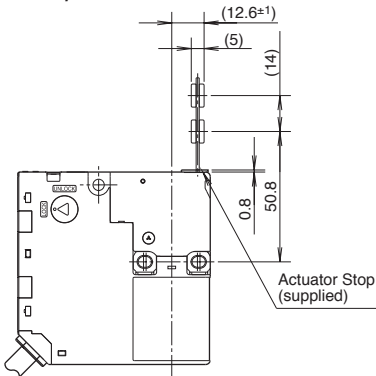

When using right-angle actuator (HS9Z-A62)

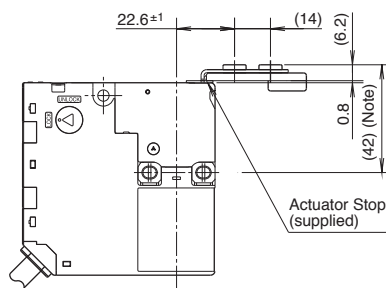

When using horizontal/vertical angle adjustable actuator (HS9Z-A65/A66)

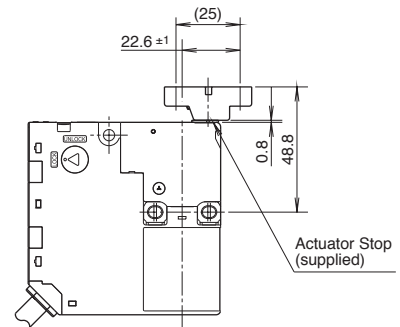

Actuator Mounting Reference Position

As shown in the figure on the right, the mounting reference position of the actuator key when inserted in the interlock switch is:

The actuator stop on the actuator lightly touches the interlock switch.



After mounting the actuator, remove the actuator stop from the actuator.

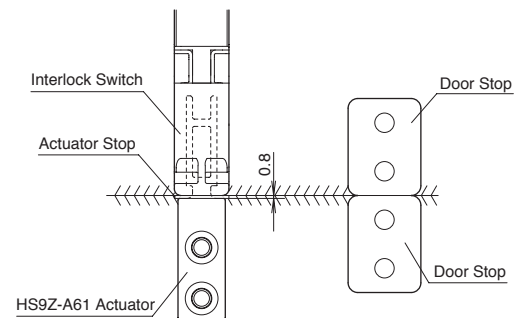

**Actuator Key Dimensions (mm)**

**Straight Actuator (HS9Z-A61)**

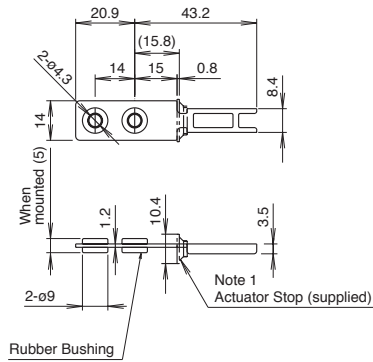

**Straight Actuator (HS9Z-A61) Right-angle Actuator (HS9Z-A62)**

The retention force of the HS9Z-A62 actuator is 100N. When tensile force exceeding 100N is expected, use the HS9Z-A62S actuator.

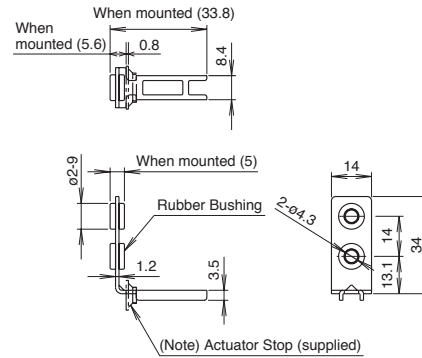

**Right-angle Actuator with Mounting Plate (HS9Z-A62S)**

Note: See page 373 for actuator installation.

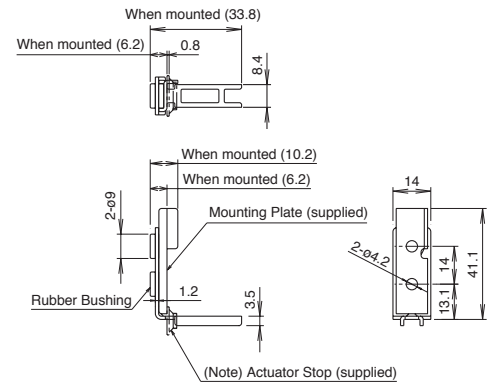

The actuator stop is used to adjust the actuator position. Remove after the actuator position is mounted.

**Angle Adjustable Actuator (HS9Z-A65)**

**Horizontal Adjustment**

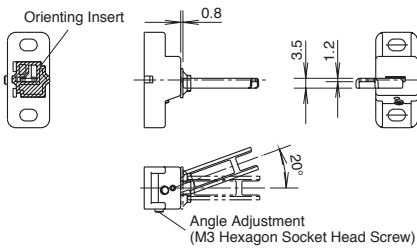

**Vertical Adjustment**

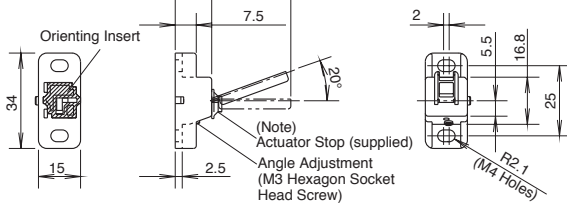

**Angle Adjustable Actuator (HS9Z-A66)**

The HS9Z-A65 and HS9Z-A66 have the metal actuator inserted in opposite directions.

**Horizontal Adjustment**

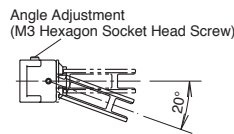

**Vertical Adjustment**

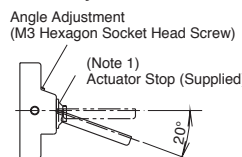

**Actuator Adjustment Orientation**

The orientation of actuator adjustment (horizontal/vertical) can be changed using the orienting insert (white plastic) installed on the back of the actuator.

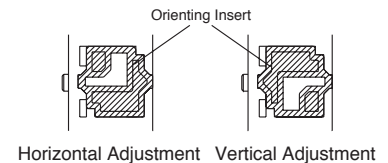

**Angle Adjustable Actuator (HS9Z-A65)**

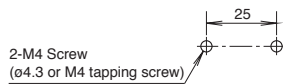

**Manual Unlock Key (plastic)**  
(supplied with switch, not replaceable)

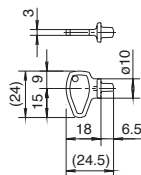

**Manual Unlock Key, HS9Z-T3 (metal)**

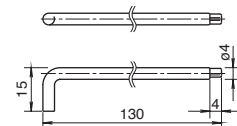

**Accessory**

Description	Part Number
Manual Unlock Key (long type)	HS9Z-T3

Circuit Diagrams and Operating Characteristics

Spring Lock Type

		Status 1	Status 2	Status 3	Status 4	Unlocking Using Manual Unlock Key	
Interlock Switch Status		<ul style="list-style-type: none"> <li>Door closed</li> <li><b>Machine ready to operate</b></li> <li>Solenoid de-energized</li> </ul>	<ul style="list-style-type: none"> <li>Door opened</li> <li>Machine cannot be operated</li> <li>Solenoid energized</li> </ul>	<ul style="list-style-type: none"> <li>Door open</li> <li>Machine cannot be operated</li> <li>Solenoid energized</li> </ul>	<ul style="list-style-type: none"> <li>Door open</li> <li>Machine cannot be operated</li> <li>Solenoid de-energized</li> </ul>	<ul style="list-style-type: none"> <li>Door closed</li> <li>Machine cannot be operated</li> <li>Solenoid de-energized</li> </ul>	
Door Status							
Circuit Diagram (Example: HS6E-N4)							
Door		Closed (locked)	Closed (unlocked)	Open	Open	Closed (unlocked)	
Part Number and Circuit Diagram	<b>HS6E-L4</b> Door Lock Monitor Main Circuit: 11, 12, 41, 42 Monitor Circuit: 21, 22, 53, 54 Monitor Circuit: 31, 32	Main Circuit 11-42	ON (closed)	OFF (open)	OFF (open)	OFF (open)	OFF (open)
		Door Monitor Circuit (door closed) 21-22	ON (closed)	ON (closed)	OFF (open)	OFF (open)	ON (closed)
		Door Monitor Circuit (door closed) 31-32	ON (closed)	ON (closed)	OFF (open)	OFF (open)	ON (closed)
		Lock Monitor Circuit (unlocked) 53-54	OFF (open)	ON (closed)	ON (closed)	ON (closed)	ON (closed)
	<b>HS6E-M4</b> Main Circuit: 11, 12, 41, 42 Monitor Circuit: 21, 22, 51, 52 Monitor Circuit: 31, 32	Main Circuit 11-42	ON (closed)	OFF (open)	OFF (open)	OFF (open)	OFF (open)
		Door Monitor Circuit (door closed) 21-22	ON (closed)	ON (closed)	OFF (open)	OFF (open)	ON (closed)
		Door Monitor Circuit (door closed) 31-32	ON (closed)	ON (closed)	OFF (open)	OFF (open)	ON (closed)
		Lock Monitor Circuit (locked) 51-52	ON (closed)	OFF (open)	OFF (open)	OFF (open)	OFF (open)
	<b>HS6E-N4</b> Main Circuit: 11, 12, 41, 42 Monitor Circuit: 21, 22, 53, 54 Monitor Circuit: 33, 34	Main Circuit 11-42	ON (closed)	OFF (open)	OFF (open)	OFF (open)	OFF (open)
		Door Monitor Circuit (door closed) 21-22	ON (closed)	ON (closed)	OFF (open)	OFF (open)	ON (closed)
		Door Monitor Circuit (door open) 33-34	OFF (open)	OFF (open)	ON (closed)	ON (closed)	OFF (open)
		Lock Monitor Circuit (unlocked) 53-54	OFF (open)	ON (closed)	ON (closed)	ON (closed)	ON (closed)
	<b>HS6E-P4</b> Main Circuit: 11, 12, 41, 42 Monitor Circuit: 21, 22, 51, 52 Monitor Circuit: 33, 34	Main Circuit 11-42	ON (closed)	OFF (open)	OFF (open)	OFF (open)	OFF (open)
		Door Monitor Circuit (door closed) 21-22	ON (closed)	ON (closed)	OFF (open)	OFF (open)	ON (closed)
		Door Monitor Circuit (door open) 33-34	OFF (open)	OFF (open)	ON (closed)	ON (closed)	OFF (open)
		Lock Monitor Circuit (locked) 51-52	ON (closed)	OFF (open)	OFF (open)	OFF (open)	OFF (open)
<b>Solenoid Power A1-A2 (all types)</b>		<b>OFF (de-energized)</b>	<b>ON (energized)</b>	<b>ON (energized)</b>	<b>OFF (de-energized)</b>	<b>OFF (de-energized)</b>	

Main circuit: Connected to the machine drive control circuit, sending the interlock signals of the protective door.  
 Monitor circuit: Sends the monitoring signals of open/closed and lock/unlocked statuses of the protective door.

Operation Characteristics (reference)

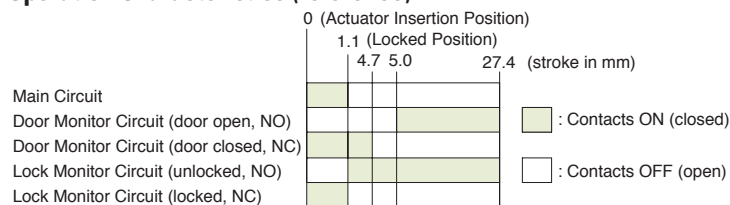

The characteristics shown in the chart above are of the HS9Z-A61, -A62, -A65, and -A66 actuators. For the HS9Z-A62S actuator, subtract 0.6 mm. The characteristics show the contact status when the actuator enters an entry slot of an interlock switch.

Solenoid Lock Type

	Status 1	Status 2	Status 3	Status 4	Unlocking Using Manual Unlock Key
Interlock Switch Status	<ul style="list-style-type: none"> <li>Door closed</li> <li><b>Machine ready to operate</b></li> <li>Solenoid energized</li> </ul>	<ul style="list-style-type: none"> <li>Door closed</li> <li>Machine cannot be operated</li> <li>Solenoid de-energized</li> </ul>	<ul style="list-style-type: none"> <li>Door open</li> <li>Machine cannot be operated</li> <li>Solenoid de-energized</li> </ul>	<ul style="list-style-type: none"> <li>Door open</li> <li>Machine cannot be operated</li> <li>Solenoid de-energized</li> </ul>	<ul style="list-style-type: none"> <li>Door open</li> <li>Machine cannot be operated</li> <li>Solenoid de-energized</li> </ul>

Door Status				
-------------	--	--	--	--

Circuit Diagram (Example: HS6E-N7Y)				
-------------------------------------	--	--	--	--

Door		Closed (locked)	Closed (unlocked)	Open	Open	Closed (unlocked)
<b>HS6E-L7Y</b>  Main Circuit: 11, 12, 41, 42 Monitor Circuit: 21, 22, 53, 54 Monitor Circuit: 31, 32	Main Circuit 11-42	ON (closed)	OFF (open)	OFF (open)	OFF (open)	OFF (open)
	Door Monitor Circuit (door closed) 21-22	ON (closed)	ON (closed)	OFF (open)	OFF (open)	ON (closed)
	Door Monitor Circuit (door closed) 31-32	ON (closed)	ON (closed)	OFF (open)	OFF (open)	ON (closed)
	Lock Monitor Circuit (unlocked) 53-54	OFF (open)	ON (closed)	ON (closed)	ON (closed)	ON (closed)
<b>HS6E-M7Y</b>  Main Circuit: 11, 12, 41, 42 Monitor Circuit: 21, 22, 51, 52 Monitor Circuit: 31, 32	Main Circuit 11-42	ON (closed)	OFF (open)	OFF (open)	OFF (open)	OFF (open)
	Door Monitor Circuit (door closed) 21-22	ON (closed)	ON (closed)	OFF (open)	OFF (open)	ON (closed)
	Door Monitor Circuit (door closed) 31-32	ON (closed)	ON (closed)	OFF (open)	OFF (open)	ON (closed)
	Lock Monitor Circuit (locked) 51-52	ON (closed)	OFF (open)	OFF (open)	OFF (open)	OFF (open)
<b>HS6E-N7Y</b>  Main Circuit: 11, 12, 41, 42 Monitor Circuit: 21, 22, 53, 54 Monitor Circuit: 33, 34	Main Circuit 11-42	ON (closed)	OFF (open)	OFF (open)	OFF (open)	OFF (open)
	Door Monitor Circuit (door closed) 21-22	ON (closed)	ON (closed)	OFF (open)	OFF (open)	ON (closed)
	Door Monitor Circuit (door open) 33-34	OFF (open)	OFF (open)	ON (closed)	ON (closed)	OFF (open)
	Lock Monitor Circuit (unlocked) 53-54	OFF (open)	ON (closed)	ON (closed)	ON (closed)	ON (closed)
<b>HS6E-P7Y</b>  Main Circuit: 11, 12, 41, 42 Monitor Circuit: 21, 22, 51, 52 Monitor Circuit: 33, 34	Main Circuit 11-42	ON (closed)	OFF (open)	OFF (open)	OFF (open)	OFF (open)
	Door Monitor Circuit (door closed) 21-22	ON (closed)	ON (closed)	OFF (open)	OFF (open)	ON (closed)
	Door Monitor Circuit (door open) 33-34	OFF (open)	OFF (open)	ON (closed)	ON (closed)	OFF (open)
	Lock Monitor Circuit (locked) 51-52	ON (closed)	OFF (open)	OFF (open)	OFF (open)	OFF (open)
<b>Solenoid Power A1-A2 (all types)</b>		<b>ON (energized)</b>	<b>OFF (de-energized)</b>	<b>OFF (de-energized)</b>	<b>ON (energized) (Note 2)</b>	OFF (de-energized) to ON (re-energized) (Note 1) (Note 2)

Main circuit: Connected to the machine drive control circuit, sending the interlock signals of the protective door.  
 Monitor circuit: Sends the monitoring signals of open/closed and lock/unlocked statuses of the protective door.

Note 1: Do not attempt manual unlocking while the solenoid is energized.  
 Note 2: Do not energize the solenoid for a long period of time while the door is open or while the door is unlocked manually using the manual unlock key.

Operation Characteristics (reference)

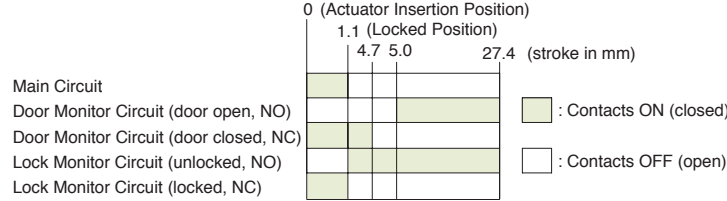

The characteristics shown in the chart above are of the HS9Z-A61, -A62, -A65, and -A66 actuators. For the HS9Z-A62S actuator, subtract 0.6 mm. The characteristics show the contact status when the actuator enters an entry slot of an interlock switch.

Overview

X Series E-Stops

Door Interlock Switches

Enabling Switches

Barriers

AS-Interface Safety at Work



Operating Instructions

Minimum Radius of Hinged Door

- When using the interlock switch on hinged doors, refer to the minimum radius of doors shown below. When using on doors with small minimum radius, use the angle adjustable actuator (HS9Z-A65 and HS9Z-A66).

Note: Because deviation or dislocation of hinged doors may occur in actual applications, make sure of the correct operation before installation.

When Using the HS9Z-A62/A62S Right-angle Actuator

- When door hinge is on the extension line of the interlock switch surface:

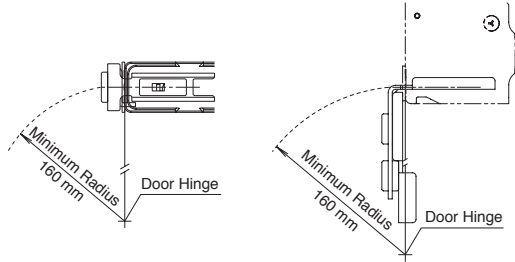

- When door hinge is on the extension line of the actuator mounting surface:

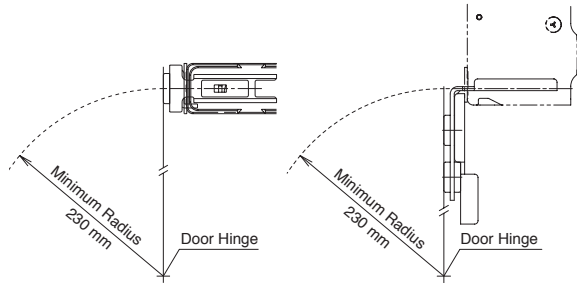

When using the HS9Z-A65/HS9Z-A66 Angle Adjustable Actuator

- When door hinge is on the extension line of the interlock switch surface

Horizontal Adjustment

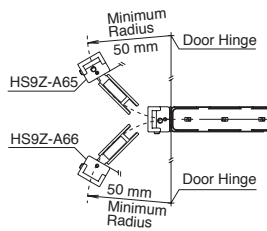

Vertical Adjustment

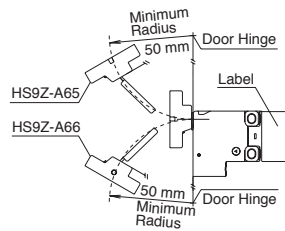

- When door hinge is on the extension line of the actuator mounting surface

Horizontal Adjustment

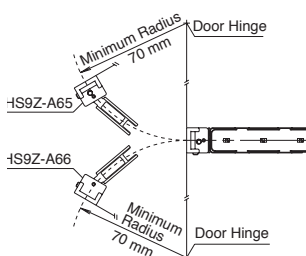

Vertical Adjustment

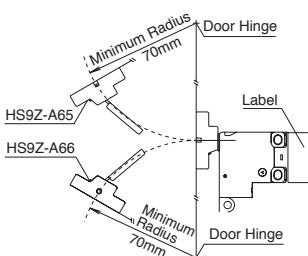

Actuator Angle Adjustment for the HS9Z-A65/HS9Z-A66

- Using the angle adjustment screw, the actuator angle can be adjusted (see figures on page 370).  
Adjustable angle: 0 to 20°

- The larger the adjusted angle of the actuator, the smaller the applicable radius of the door opening.
- After installing the actuator, open the door. Then adjust the actuator so that its edge can enter properly into the actuator entry slot of the interlock switch.
- After adjusting the actuator angle, apply Loctite to the adjustment screw so that the screw will not become loose.

Mounting Examples

Application on Sliding Doors

Application on Hinged Doors

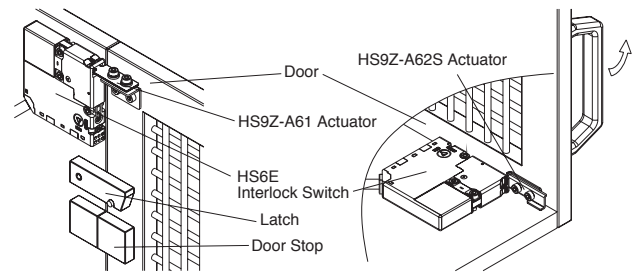

Note: When mounting the actuator, make sure that the actuator enters the slot in the correct direction, as shown on the right.

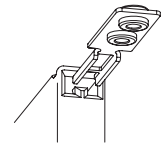

## For Manual Unlocking

### Spring lock type

The HS6E allows manual unlocking of the actuator to pre-check proper door operation before wiring or turning power on, as well as for emergency use such as a power failure.

### Solenoid lock type

The HS6E can be unlocked manually in an emergency.

### When using the manual unlock key

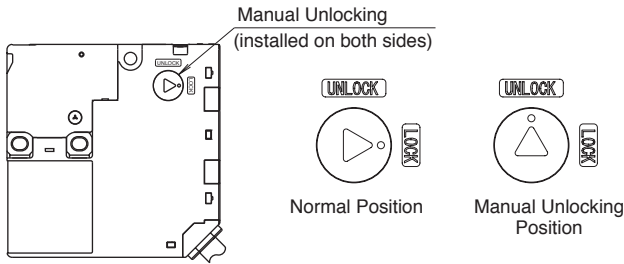

- When locking or unlocking the interlock switch manually, turn the actuator fully using the manual unlock key supplied with the switch.
- Using the interlock switch with the actuator not fully turned (less than 90°) may cause damage to the interlock switch or operation failures (when manually unlocked, the switch will keep the main circuit disconnected and the door unlocked).
- Do not apply excessive force (0.45 N·m or more) to the manual unlock part, otherwise the manual unlock part will become damaged.
- Do not leave the manual unlock key attached to the switch during operation. This is dangerous because the switch can always be unlocked while the machine is in operation.

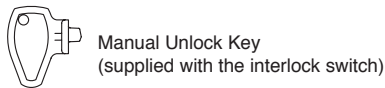

### When unlocking pushing the plate inside the interlock switch

- Remove the screw at the side of the interlock switch (the same side where actuator is inserted) and insert a small screwdriver.
- Push the plate inside the interlock switch toward the LED indicator using a screwdriver until the actuator is unlocked.
- Tighten the screw to a proper torque (0.3 to 0.5 N·m). Do not tighten with excessive force, otherwise the interlock switch will be damaged. Be sure to reinstall the screw, otherwise the waterproof capability will be lost.

### Caution

Before manually unlocking the interlock switch, make sure that the machine has come to a complete stop. Manual unlocking during operation may unlock the interlock switch before the machine stops, and the function of the interlock switch with solenoid is lost. While the solenoid is energized, do not unlock the switch manually (solenoid lock type).

## Recommended Tightening Torque of Mounting Screws

- Interlock switch: 1.0 to 1.5 N·m (three M4 screws)
- Actuators: 1.0 to 1.5 N·m (two M4 screws)
- The above recommended tightening torques of the mounting screws are the values with hex socket head bolts. When other screws are used and tightened to a smaller torque, make sure that the screws do not become loose after mounting.
- Mounting bolts are not supplied with the interlock and must be supplied by the user.
- To avoid unauthorized or unintended removal of the interlock switch and the actuator, it is recommended that the interlock switch and the actuator are installed in an unremovable manner, for example using special screws, rivets, or welding the screws.
- When installing the HS9Z-A62S actuator, use the mounting plate (supplied with the actuator) on the hinged door, and secure the actuator tightly using two M4 screws.
- The mounting plate has an orientation.
- Do not lose the mounting plate.

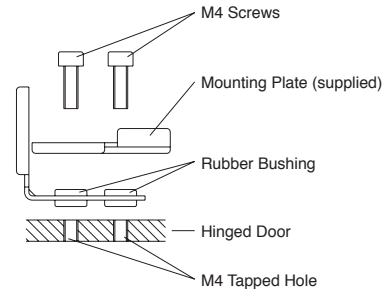

## Cables

- Do not fasten or loosen the gland at the bottom of the interlock switch.
- When bending the cable during wiring, make sure that the cable radius is kept at 30 mm minimum.
- When wiring, make sure that water or oil does not enter from the end of the cable.
- Do not open the lid of the interlock switch. Otherwise the interlock switch will be damaged.
- The solenoid has polarity. Make sure of the correct polarity when wiring.

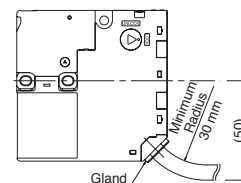
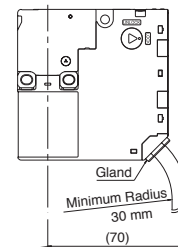

## Wire Identification

- Wires can be identified by color and or a white line printed on the wire.

No.	Insulation Color	No.	Insulation Color
1	Blue/White	7	White
2	Gray	8	Black
3	Pink	9	Pink/White
4	Orange	10	Brown/White
5	Orange/White	11	Brown
6	Gray/White	12	Blue

## Terminal Number Identification

- When wiring, identify the terminal number of each contact by the color of the insulation.
- The following table shows the identification of terminal numbers.
- When wiring, cut unused wires to avoid incorrect wiring.

Type	Contact Arrangement	
HS6E-L		
	Main circuit: Blue	11 → 12 → 41 → 42 Blue/White
	Monitor circuit: Brown	21 → 22 Brown/White Pink 53 → 54 Pink/White
	Monitor circuit: Orange	31 → 32 Orange/White
HS6E-M	Main circuit: Blue	11 → 12 → 41 → 42 Blue/White
	Monitor circuit: Brown	21 → 22 Brown/White Pink 51 → 52 Pink/White
	Monitor circuit: Orange	31 → 32 Orange/White
HS6E-N	Main circuit: Blue	11 → 12 → 41 → 42 Blue/White
	Monitor circuit: Brown	21 → 22 Brown/White Pink 53 → 54 Pink/White
	Monitor circuit: Orange	33 → 34 Orange/White
HS6E-P	Main circuit: Blue	11 → 12 → 41 → 42 Blue/White
	Monitor circuit: Brown	21 → 22 Brown/White Pink 51 → 52 Pink/White
	Monitor circuit: Orange	33 → 34 Orange/White

Note: The contact arrangements show the contact status when the actuator is inserted and locked.

### Safety Precautions

- In order to avoid electric shock or a fire, turn the power off before installation, removal, wire connection, maintenance, or inspection of the switch.
- If relays are used in the circuit between the safety switch and the load, consider degrees of the danger and use safety relays, since welded or sticking contacts of standard relays may invalidate the functions of the safety switch.
- Do not place a PLC in the circuit between the safety switch and the load. The safety security can be endangered in the event of a malfunction of the PLC.
- Do not disassemble or modify the switch. It may cause a breakdown or an accident.

### Operation Precautions - for all series

- Regardless of door types, do not use the safety switch as a door stop. Install a mechanical door stop at the end of the door to protect the safety switch against excessive force.
- Do not apply excessive shock to the switch when opening or closing the door.
- A shock to the door exceeding 1,000 m/sec<sup>2</sup> (approx. 100G) may cause the contacts of the switch to chatter, and a malfunction of the switch may occur.
- For connection of wires, unscrew the cover. Unnecessary loosening of other screws may cause a malfunction of the switch.
- Prevent foreign objects such as dust and liquids from entering the switch while connecting conduit or wiring.
- If the operating atmosphere is contaminated, use a protective cover to prevent the entry of foreign objects into the switch through the actuator entry slots.
- Entry of a considerable amount of foreign objects into the switch may affect the mechanism of the switch and cause a breakdown.
- Do not store the switches in a dusty, humid, or organic-gas atmosphere.

### HS5E/HS5B Precautions

#### For Rotating Head Directions

- The heads of the HS5E/HS5B can be rotated in 90° increments after removing the 4 screws on the corners of the head. Prevent entry of foreign objects into the switch during removal of the head. Tighten these screws with torque designated in the instruction sheet. Improper torque may cause errors.

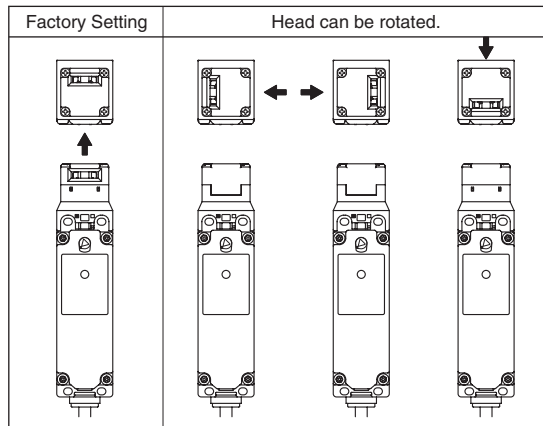

#### Minimum Radius of Hinged Doors

- When using the interlock switch on hinged doors, refer to the minimum radius of doors shown below. When using on doors with small minimum radius, use the angle adjustable actuator (HS9Z-A55).

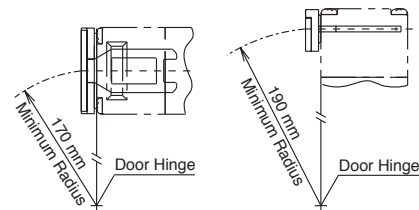

- When door hinge is on the extension line of the actuator mounting surface:

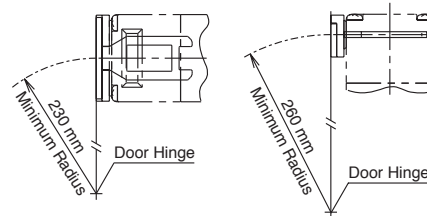

### HS2B Precautions

#### Wire Connection

- The HS2B has 3 conduit ports, which are closed as a part of the molded switch housing.
- Make an opening for wire connection by breaking one of the conduit-port knockouts on the switch housing using a screwdriver.
- When breaking the conduit port, take care not to damage the contact block or other parts inside the switch.

- Cracks or burrs on the conduit entry may deteriorate the housing protection against water.
- When changing to another conduit port, close the unused opening with an optional plug (Part No. HS9Z-P1).

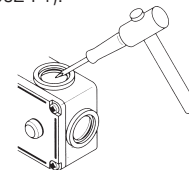

### HS1E Precautions

#### Wire Connection

- Make an opening for wire connection by breaking one of the conduit-port knockouts on the switch housing using a screwdriver.
- Before breaking the knockout, temporarily remove the connector-fixing lock nut from the switch.
- When breaking the knockout, take care not to damage the contact block or other parts inside the switch.
- Cracks or burrs on the conduit entry may deteriorate the housing protection.
- When changing to the other conduit port, close the unused opening with an optional plug (accessory).

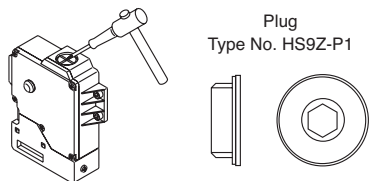

#### Manual Unlocking

- Remove the screw located on the unlocking entry at the side of the switch using the key wrench included with the switch. Then insert a small screwdriver into the switch to push the lever inside of the switch toward the indicator until the actuator is unlocked (refer to the diagram on the right).
- Insert a small screwdriver into the elliptical hole on the back of the switch, then push the lever inside of the switch toward the indicator until the actuator is unlocked (refer to the diagram on the right).



1. This unlocking method is intended for an escape from a machine when a person is locked in. For access to the unlocking entry, an access hole should be opened on the mounting panel. When opening the hole, apply proper protection against water or other foreign objects.
2. Caution: After the unlocking operation, put the screw back into the unlocking entry for safety.

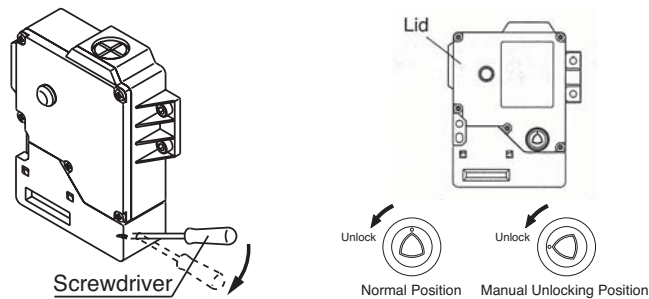

### HS1C Precautions

- Regardless of door type, do not use the safety switch as a locking device. Install a locking device independently, for example, using a metal latch (also applicable to HS1E).
- The safety switch cover can be only removed with the special key wrench supplied with the switch or with the optional screwdriver (also applicable to HS1B and HS1E).
- Remove the screw located on the unlocking entry at the side of the switch using the key wrench included with the switch. Then insert a small screwdriver into the switch to push the lever inside of the switch toward the indicator until the actuator is unlocked (refer to the diagram on the right).



Caution: After the unlocking operation, put the screw back into the unlocking entry for safety.

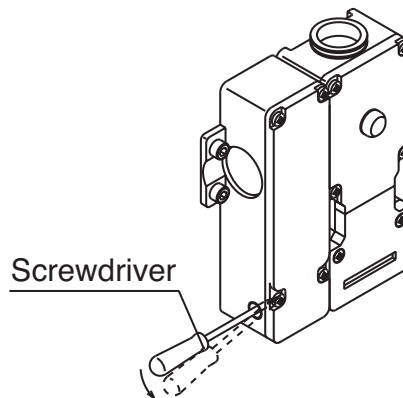

Operation Precautions

Applicable Crimping Terminals

- (Refer to the Crimping Terminal 1 or 2 shown in the drawing below.)
- HS1C  
Terminals No. 1 to 6: Use solid or stranded wires only (crimping terminals not applicable).  
Terminals No. 7 and 8: Crimping Terminal 1  
Ground Terminal: Crimping Terminal 2
- HS1B  
Ground Terminal: Crimping Terminal 2  
Other Terminals: Crimping Terminal 1  
HS2B, HS5B, and HS1E  
Crimping Terminal 1

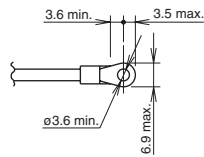

Crimping Terminal 1

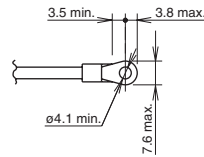

Crimping Terminal 2



Use an insulation tube on the crimping terminal.

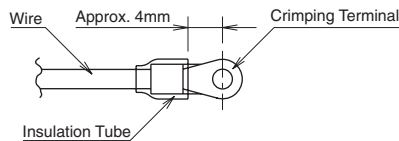

Installation Examples (see the diagrams below)

Mounting on Sliding Doors

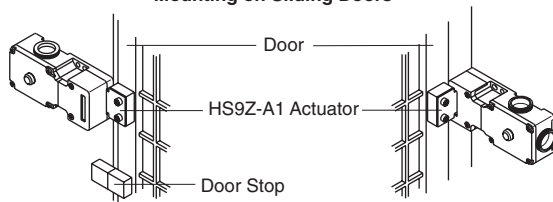

Mounting on Hinged Doors

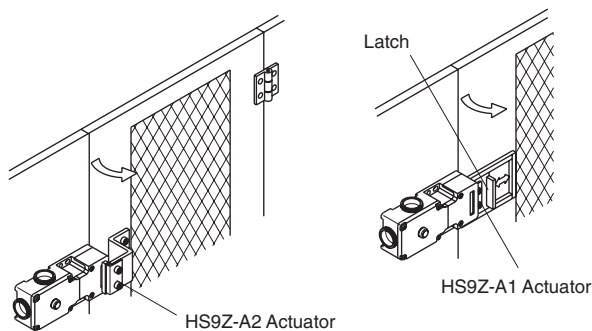

Applicable Connectors (As shown below)

- Use connectors which maintain the IP67 protection.
- Applicable Connector Dimensions
- Flex Conduit: VF03 (Japan Flex) www.nipolex.co.jp
- Steel Connector (G1/2): ALC-103 (PF13.5): RBC-103PG13.5

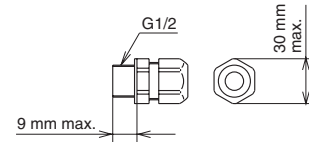

Recommended Screw Tightening Torque

- HS1C: 5.0±0.5 N-m (approx. 50±5 kgf-cm)  
(4 or 6 pcs of M5 hex socket head cap screws)
- HS1B: 5.0±0.5 N-m (approx. 50±5 kgf-cm)  
(2 or 4 pcs. of M5 hex socket head cap screws)
- HS2B: 5.0±0.5 N-m (approx. 50±5 kgf-cm)  
(2 pcs of M5 hex socket head cap screws)
- HS5B: 4.0±0.4 N-m (approx. 40±4 kgf-cm)  
(2 pcs of M4 hex socket head cap screws)
- HS1E: 5.0±0.5 N-m (approx. 50±5 kgf-cm)  
(4 or 6 pcs of M5 hex socket head cap screws)
- Actuator (HS9Z-A1/A2)  
5.0±0.5 N-m (approx. 50±5 kgf-cm)
- (2 pcs. of M6 hex socket head cap screws)  
Actuator (HS9Z-A51/A52)
- 2.0±0.2 N-m (approx. 20±2 kgf-cm)  
(2 pcs of M4 hex socket head cap screws)
- 1.0±0.2 N-m (approx. 10±2 kgf-cm)  
(2 pcs of M4 Phillips screws)



The screws are supplied by the user.

Applicable Wire Size

- HS1C: 0.5 to 0.75 mm<sup>2</sup> (Terminals No.1, 2, 5 to 8)  
1.0 to 1.25 mm<sup>2</sup> (Terminals No.3, 4, and grounding terminal)
- HS5B: 0.5 to 1.25 mm<sup>2</sup>
- HS1E: 0.5 to 1.25 mm<sup>2</sup>

**Actuator Angle Adjustment**

- Using the screw (M3 hex socket head screw), the actuator angle can be adjusted (refer to the dimensional drawing). Adjustable angle: (0°) to 20°
- The larger the adjusted angle of the actuator, the smaller the applicable radius of the door opening.

- After installing the actuator, open the door. Then adjust the actuator so that its edge can be inserted properly into the entry slot of the safety switch.
- Recommended tightening torque: 0.8 N-m (approx. 8.0 kgf-cm)
- After adjusting the actuator angle, apply loctite or the like to the adjustment screw so as to prevent its loosening.

**Minimum Radius of Hinged Door**

- When using the interlock switch on hinged doors, refer to the minimum radius of doors shown below. When using on doors with small minimum radius, use the angle adjustable actuator (HS9Z-A55).

Note: Because deviation or dislocation of hinged doors may occur in actual applications, make sure of the correct operation before installation.

**When using the HS9Z-A52 Actuator**

- When the door hinge is on the extension line of the interlock switch surface:

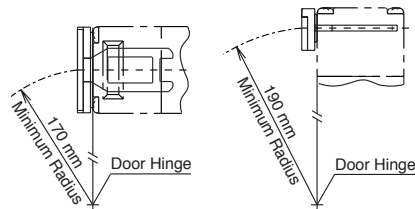

- When door hinge is on the extension line of the actuator mounting surface:

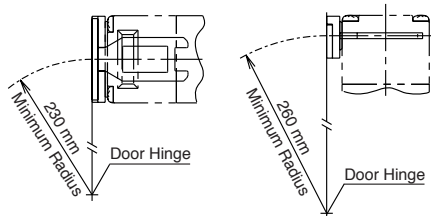

**When using the HS9Z-A55 Angle Adjustable Actuator**

- When door hinge is on the extension line of the interlock switch surface: 50 mm
- When door hinge is on the extension line of the actuator mounting surface: 70 mm

**Horizontal Swing**

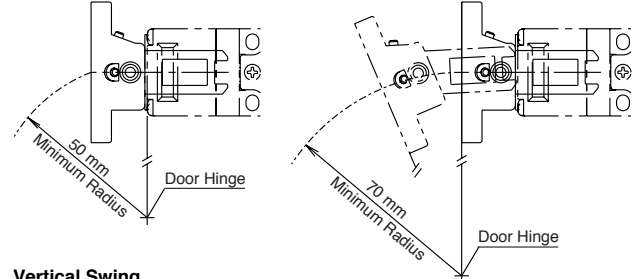

**Vertical Swing**

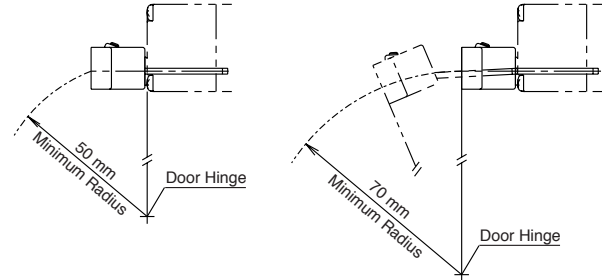

**Actuator Angle Adjustment for the HS9Z-A55**

- Using the angle adjustment screw, the actuator angle can be adjusted (see figures on page 370). Adjustable angle: 0 to 20°
- The larger the adjusted angle of the actuator, the smaller the applicable radius of the door opening.
- After installing the actuator, open the door. Then adjust the actuator so that its edge can be inserted properly into the actuator entry slot of the interlock switch.
- After adjusting the actuator angle, apply Loctite to the adjustment screw so that the screw will not loosen.

**Applicable Cable Glands**

Use a cable gland with a degree of protection IP67

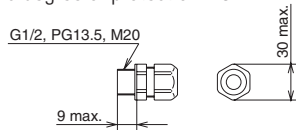

all dimensions in mm

**When Using Flexible Conduits (Example)**

Flexible conduit example: VF-03 (Nihon Flex)

Conduit Port Size	Plastic Cable Gland	Metal Cable Gland
G1/2	—	RLC-103 (Nihon Flex)
PG13.5	—	RBC-103PG13.5 (Nihon Flex)
M20	—	RLC-103EC20 (Nihon Flex)

**When Using Multi-core Cables (Example)**

Conduit Port Size	Plastic Cable Gland	Metal Cable Gland
G1/2	SCS-10* (Seiwa Electric)	ALS-16** (Nihon Flex)
PG13.5	ST13.5 (K-MECS)	ABS-**PG13.5 (Nihon Flex)
M20	ST-M20X1.5 (K-MECS)	ALS-**EC20 (Nihon Flex)

- Different cable glands are used depending on the cable sheath outside diameter. When purchasing a cable gland, confirm that the cable gland is applicable to the cable sheath outside diameter.
- When using a 1/2-14NPT cable gland, use the HS5B interlock switch with M20 conduit port (Part No.: HS5B-\*\*\*BM) together with an adapter (Part No.: MA-M/NPT 20X1.5 5402-0110, K-MECS) and a gasket (Part No.: GP M20, K-MECS). Install a gasket between the interlock switch and the adapter. Apply sealing tape between the cable gland and the adapter to make sure of IP67 protection for the enclosure.